

Instruction Manual

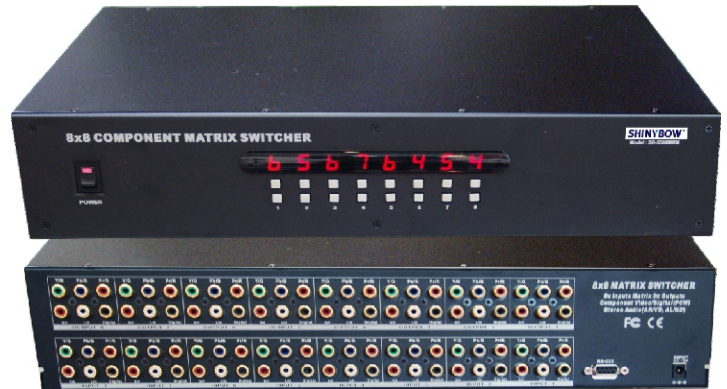

MODEL : SB-5588
8x8 COMPONENT-AUDIO MATRIX SWITCHER

Component Matrix Switcher Series

Thank you for purchasing the SB-5588 Component Matrix Switcher. You will find this unit easy to install and highly reliable but it is essential that you read this manual thoroughly before attempting to use 8x8 Component Video-Digital-Audio Matrix Switcher.



SAFETY INFORMATION



1. Save the carton and packing material even if the equipment has arrived in good condition. Should you ever need to ship the unit, use only the original factory packing.
2. Read all documentation before operating your equipment. Retain all documentation for future reference.
3. Follow all instructions printed on unit chassis for proper operation.
4. Do not spill water or other liquids into or on the unit, or operate the unit while standing in liquid.
5. Make sure power outlets conform to the power requirements listed on the back of the unit.
6. Do not use the unit if the electrical power cord is frayed or broken. The power supply cords should be routed so that they are not likely to be walked on or pinched by items placed upon or against them, paying particular attention to cords and plugs, convenience receptacles, and the point where they exit from the appliance.
7. Always operate the unit with the AC ground wire connected to the electrical system ground. Precautions should be taken so that the means of grounding of a piece of equipment is not defeated.
8. Mains voltage must be correct and the same as that printed on the rear of the unit. Damage caused by connection to improper AC voltage is not covered by any warranty.
9. Power down & disconnect unit from mains voltage before making connections.
10. Never hold a power switch in the " ON " position.
11. Do not use the unit near stoves, heat registers, radiators, or other heat Producing devices.
12. Do not block fan intake or exhaust ports. Do not operate equipment on a surface or in an environment which may impede the normal flow of air around the unit, such as a bed, rug, carpet, or completely enclosed rack. If the unit is used in an extremely dusty or smoky environment, the unit should be Periodically " blown free " of foreign matter.
13. Do not remove the cover. Removing the cover will expose you to potentially dangerous voltages. There are no user serviceable parts inside.
14. Do not drive the inputs with a signal level greater than that required to drive equipment to full output.
15. Non-use periods. The power cord of equipment should be unplugged from the outlet when left unused for a long period of time.
16. Service Information Equipment should be serviced by qualifier service personnel when:
 - A. The power supply cord or the plug has been damaged.
 - B. Objects have fallen, or liquid has been spilled into the equipment.
 - C. The equipment has been exposed to rain
 - D. The equipment does not appear to operate normally, or exhibits a marked change in performance
 - E. The equipment has been dropped, or the enclosure damaged.

IMPORTANT SAFETY INSTRUCTIONS

To insure the best from this product, please read this manual carefully. Keep it in a safe place for future reference.

To reduce the risk of electric shock, do not remove the cover from the unit. No user serviceable parts inside. Refer servicing to qualified personnel.

To reduce the risk of fire, do not expose the unit to rain, water or excessive moisture.

Do not force switched or external connections.

When moving the unit disconnect the serial port connections first then the power cable and finally the interconnecting cables to other devices.

Do not attempt to clean the unit with chemical solvents or aerosol cleaners, as this may damage the unit. Use a clean dry cloth.

Installation of this unit should be in a cool dry place, away from sources of excessive heat, vibration, dust, moisture and cold.

TABLE OF CONTENTS & INTRODUCTION

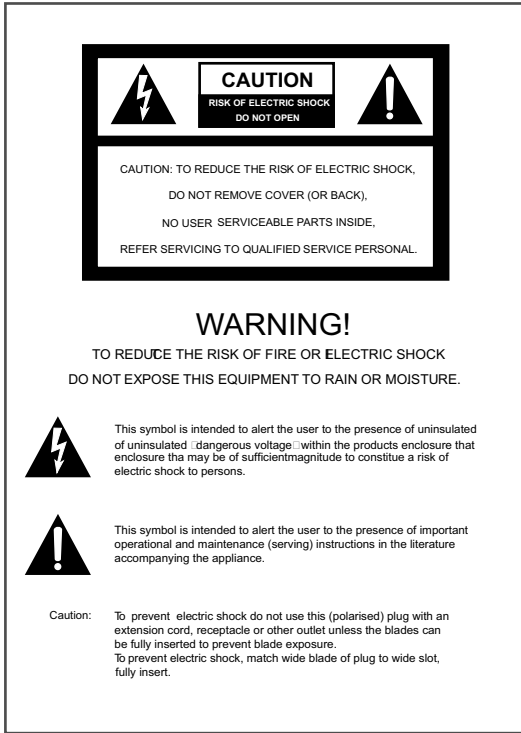

TABLE OF CONTENTS & INTRODUCTION	3
FRONT PANEL	4
REAR PANEL	5
REMOTE CONTROL	6
FEATURES & SPECIFICATIONS	7
RS232 SERIAL INTERFACE	8
RS232 SERIAL PROTOCOL COMMANDS	9
TYPICAL APPLICATION	10
LIMITED WARRANTY	11

INSTRUCTION

Congratulations on your purchase of one of the most innovative Component/Digital/Audio matrix switching products on the market Today. The SB-5588 is a true Matrix Routing Switcher for Component Video, Digital and Stereo Audio signals. It is a 8 individual Component inputs with 8 individual Component outputs. Because it is a matrix router, any input may be routed to any output; or the same input may be routed to all outputs or any combination. It completely eliminates the need to constantly move around audio and video input and output cables. The SB-5588 is useful for Matrix signals from AV source devices (such as: VCRs, Camcorders, Video Game Consoles, Video CDs, DVDs, Satellite Receivers, CATV Set Top Boxes, etc.) to AV destination devices (such as: LCD TV, HDTV, Plasma displays, Projectors, etc.). Selection of inputs is made via the Front Panel push buttons or an Infrared Remote Control unit or RS 232 control by computer.

PACKAGE CONTENTS

Before attempting to use this unit, please check the packaging and make certain the following items are contained in the shipping carton :

1. Main console unit
2. Operating Instructions
3. IR Remote Controller (SW-5588A)
4. 19 inch 2D(2U) high Ear mount pair
5. RS232 DRV package
6. Power Supply 12VDC, Universal Type 50/60Hz, 100~230 VAC

Note :

Please retain the original packing material should the need ever arise to return the unit. If you find any items are missing, contact your reseller or Shinybow immediately. Have the model number, Serial Number and Invoice available for reference when you call.

FRONT PANEL

FRONT PANEL

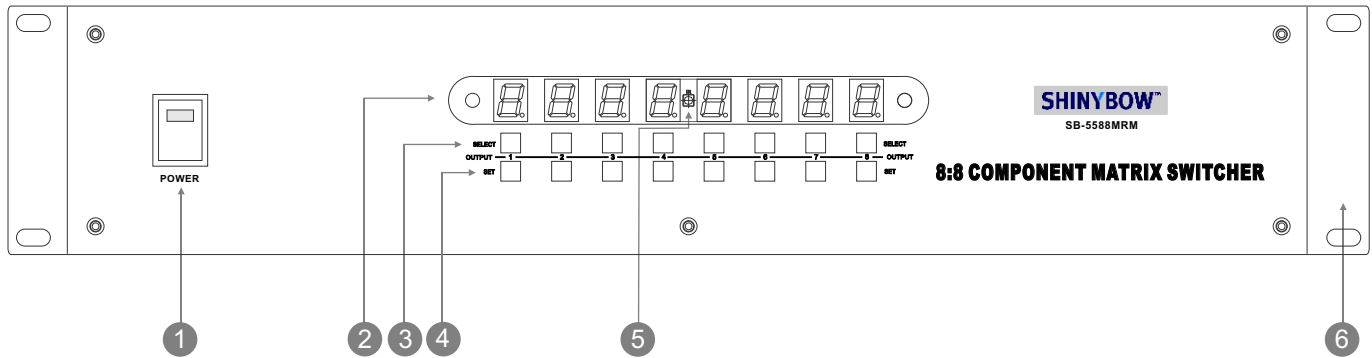

1 POWER ON SWITCH

The power switch turns the unit on and off.
The LED will illuminate red to indicate that the switcher is ON and is receiving power

2 OUTPUT SOURCES STATUS LED DISPLAY

Output channel 1 to 8 show from LED display illuminates red to indicate that a video source is present on that input.

3 INPUT SOURCES SELECT BUTTONS

A separate output-1 To 8 source select buttons are provided for each destination.
Select sources are 1-8 Component video-Audio

4 SOURCES SETUP BUTTONS

Setup the input sources 1 ~ 8 channel

5 IR SENSOR

The IR sensor receives IR commands from the supplied remote controller.

6 19 INCH EAR MOUNT PAIR

19 inch 2U(2D) high case Ear Mount pair
Part number : 2U-440L

EXP. : HOW TO SWITCH CH-08 WHEN WORKING ON CH-01

Please press < Select > push button till CH-08, then press < SET > push button to confirm.

PS : If without press < SET > push button to confirm within 1 second, LED display will flash five times for time interval and return back to CH-01.

OPERATING THE UNIT

Once you have connected the SB-5588 as described above, you must be certain that the input are being fed appropriate signals and are not suffering from signal loss due to cabling problems or problems with the source device.

If the input signals to the SB-5588 are appropriate, switch the power switch to <ON> and you should see and hear the signals on the devices you have connected to the various output connectors of the SB-5588.

POWER AND CONNECTIONS

This unit is not disconnected from the AC power source as long as it is connected to the wall outlet. The off state for this unit is called standby mode. In standby mode the unit is designed to consume a reduced quantity of power compared to normal operating modes.

When not using the unit for a long period of time. Insure that the AC power cord is disconnected from the wall outlet.

The AC wall outlet should be installed near to the unit and be easily accessible.

Do not plug in or attempt to operate an obviously damaged unit.

REAR PANEL

REAR PANEL

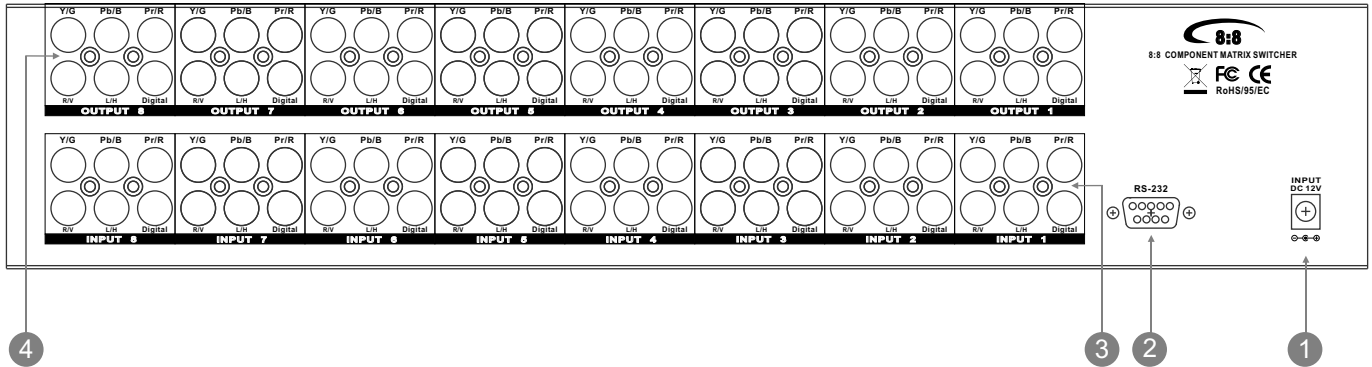

1 DC POWER INLET

The SB-5588 is fitted with a DC power plug-park input connector. Please ensure that the plug-park used is of an approved type and is of sufficient current carrying capacity with the correct voltage and connector polarity. 12Volt DC power supply 2A Max.



Power Jack:
DC Jack - inner OD \varnothing 2.1mm (+)
Outside OD \varnothing 5.5mm (GND)
Power input - 12VDC, 2A

2 RS 232 CONNECTION

RS 232 control port to allow for interfacing to a PC. Such as a computer or touch panel control, to the SB-5588 switcher via this DB-9pin Female connector for serial RS-232 control.

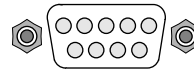

Remote port :
DB-9pin Female connector

3 INPUTS-1~8 COMPONENT-DIGITAL-AUDIO

Connect a signal source of Component Video(YPBPR)/digital Audio(PCM)/Stereo Audio devise to 8:8 switcher.

Input 1~8 port source signals :

- Component Video(YPBPR), 3x RCA Connectors
- Digital Audio (PCM), 1x RCA Connector
- Stereo Audio(AR/AL), 2x RCA Connectors

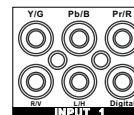

Component Video (YPbPr) Via 3x RCAs
Digital Audio(PCM) Via 1x RCA connector
Stereo Audio(AR/AL) Via 2x RCA connectors

Note:
With 6x RCA female connectors.

4 OUTPUTS-1~8 COMPONENT-DIGITAL-AUDIO

Connect a signal of Component Video(YPbPr),digital video & audio direct to Female RCA connector. This connector supports component video, digital video & audio to HDTV display device.

Output 1~8 display port signals :

- Component Video(YPbPr), 3x RCA Connectors
- Digital Audio (PCM), 1x RCA Connector
- Stereo Audio(AR/AL), 2x RCA Connectors

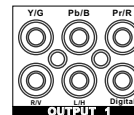

Component Video (YPbPr) Via 3x RCAs
Digital Audio(PCM) Via 1x RCA connector
Stereo Audio(AR/AL) Via 2x RCA connectors

Note:
With 6x RCA female connectors.

CONNECTING THE HARDWARE

Please study the panel drawings below and become familiar with the signal input-output, Power requirements plus any controls present.

Before using the SB-5588, please take the time to make certain that the device you wish to connect to its inputs is functioning properly in all respects. Verify that the video and audio signals are present and are being displayed properly on a suitable device.

If all is well connect the appropriate cables between the output of the device you wish to distribute to output(s) of the SB-5588 to the various devices you wish to feed a signal to. Lastly, connect the AC to DC adaptor, connect the DC connector to the SB-5588 first and then plug the adaptor into a functional AC outlet.

REMOTE CONTROL

Before making any connections to the SB-5588. Observe the following:

- > Ensure the mains voltage supply matches the label on the supplied plug-Pack (+/- 10%)
- > Ensure that the power switch is OFF
- > Ensure that all system grounds (earth) are connected to a common point.
- > Avoid powering equipment within a system from multiple power sources that may be separated by large distance
- > Connect all audio video sources and destination equipment
- > power up all source and destination audio-visual sources
- > For each destination output select the appropriate input source by using The front panel input 1~8 select buttons. The supplied IR remote control. Or through the RS 232 serial communications port.
- > Upon power up the switcher will return to its last used setting before Powered down.

REMOTE CONTROL

- 1 2 SWITCH POWER ON or OFF**
Controller with a separate power ON and OFF

3 INPUT 1~8 TV DISPLAYS INPUTS SETUP

- Input -1 : TV-1 Component Video (YPbPr) HDTV Display
- Input -2 : TV-2 Component Video (YPbPr) HDTV Display
- Input -3 : TV-3 Component Video (YPbPr) HDTV Display
- Input -4 : TV-4 Component Video (YPbPr) HDTV Display
- Input -5 : TV-5 Component Video (YPbPr) HDTV Display
- Input -6 : TV-6 Component Video (YPbPr) HDTV Display
- Input -7 : TV-7 Component Video (YPbPr) HDTV Display
- Input -8 : TV-8 Component Video (YPbPr) HDTV Display

4 INPUT 1~8 AV SOURCES OUTPUTS SETUP

- Output -1 : AV-1 Component Video (YPbPr) Signal source device
- Output -2 : AV-2 Component Video (YPbPr) Signal source device
- Output -3 : AV-3 Component Video (YPbPr) Signal source device
- Output -4 : AV-4 Component Video (YPbPr) Signal source device
- Output -5 : AV-5 Component Video (YPbPr) Signal source device
- Output -6 : AV-6 Component Video (YPbPr) Signal source device
- Output -7 : AV-7 Component Video (YPbPr) Signal source device
- Output -8 : AV-8 Component Video (YPbPr) Signal source device

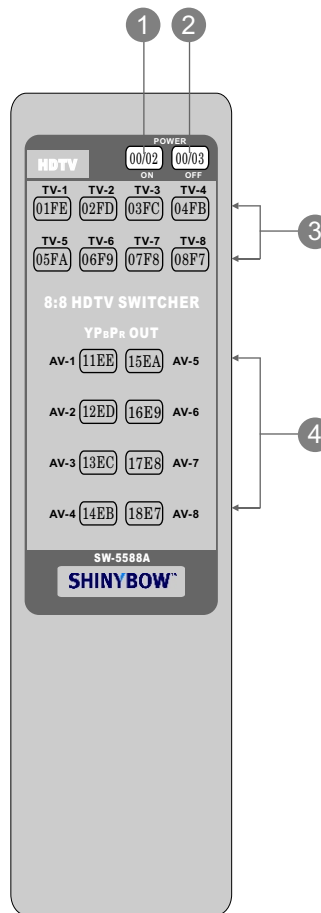

HOW TO CONTROL IR CODES

POWER ON : 00FF 02FD
POWER OFF : 00FF 03FC

TV-IN / AV OUT

INPUT#1 / OUTPUT#1 : 01FE 11EE
INPUT#1 / OUTPUT#2 : 01FE 12ED
INPUT#1 / OUTPUT#3 : 01FE 13EC
INPUT#1 / OUTPUT#4 : 01FE 14EB
INPUT#1 / OUTPUT#5 : 01FE 15EA
INPUT#1 / OUTPUT#6 : 01FE 16E9
INPUT#1 / OUTPUT#7 : 01FE 17E8
INPUT#1 / OUTPUT#8 : 01FE 18E7

INPUT#2 / OUTPUT#1 : 02FD 11EE
INPUT#2 / OUTPUT#2 : 02FD 12ED
INPUT#2 / OUTPUT#3 : 02FD 13EC
INPUT#2 / OUTPUT#4 : 02FD 14EB
INPUT#2 / OUTPUT#5 : 02FD 15EA
INPUT#2 / OUTPUT#6 : 02FD 16E9
INPUT#2 / OUTPUT#7 : 02FD 17E8
INPUT#2 / OUTPUT#8 : 02FD 18E7

INPUT#3 / OUTPUT#1 : 03FC 11EE
INPUT#3 / OUTPUT#2 : 03FC 12ED
INPUT#3 / OUTPUT#3 : 03FC 13EC
INPUT#3 / OUTPUT#4 : 03FC 14EB
INPUT#3 / OUTPUT#5 : 03FC 15EA
INPUT#3 / OUTPUT#6 : 03FC 16E9
INPUT#3 / OUTPUT#7 : 03FC 17E8
INPUT#3 / OUTPUT#8 : 03FC 18E7

INPUT#4 / OUTPUT#1 : 04FB 11EE
INPUT#4 / OUTPUT#2 : 04FB 12ED
INPUT#4 / OUTPUT#3 : 04FB 13EC
INPUT#4 / OUTPUT#4 : 04FB 14EB
INPUT#4 / OUTPUT#5 : 04FB 15EA
INPUT#4 / OUTPUT#6 : 04FB 16E9
INPUT#4 / OUTPUT#7 : 04FB 17E8
INPUT#4 / OUTPUT#8 : 04FB 18E7

CONNECTING THE HARDWARE

Please study the panel drawings below and become familiar with the signal input-output, Power requirements plus any controls present.

Before using the switcher, please take the time to make certain that the device you wish to connect to its inputs is functioning properly in all respects. Verify that the video and audio signals are present and are being displayed properly on a suitable device.

If all is well connect the appropriate cables between the output of the device you wish to distribute to output(s) of the switcher to the various devices you wish to feed a signal to. Lastly, connect the AC to DC adaptor, connect the DC connector to the switcher first and then plug the adaptor into a functional AC outlet.

FEATURES & SPECIFICATIONS

FEATURES

1. Supports 8x inputs to 8x outputs Component Video(YPBPR) Matrix Switcher
2. Input/Output signals via Component Video(YPBPR), Digital(PCM), Stereo Audio(AR/AL)
3. Higher Video Bandwidth 325MHz each path signals.
4. Supported HDTV high definition resolutions 480p, 576i/p, 720p, 1080i/1080p
5. Digital Audio (PCM) and Composite Video compliant
6. Compatible with all Component Video devices, Plasma TV display and HDTV
7. Supported RS232 serial interface protocol commands list
8. Control PC RS232 Drive compatible with win-95/98/2000/xp
9. Various User Interface controls:
 - Attached Window based control software for Desktop or NB control by RS232 port
 - Manual controlled by Front Panel button
 - IR remote control
10. Support desktop with Ear mount and 19 inch Rack mountable type panel
11. Power supply DC12Volt, Universal Type Switch 100~230VAC, 50/60Hz

SPECIFICATIONS

Type of Switcher:	8 in To 8 out, Component Video-Digital-Audio Matrix Switcher
I/O Signals:	Component Video (YPBPR) 0.5~1.0Vpp, DDC 5Vpp, Digital Audio (PCM), Via 1x RCA connector Stereo Audio (AR/AL), Via 2x RCA connector(Red/white)
Video Bandwidth :	325MHz (-3db), 200mVp-p
Video Supported:	Higher resolution formats 480i/p, 720p & 1080i/p
Audio Supported:	Digital Audio(PCM) and Stereo Audio(AR/AL)
Low all hostile crosstalk:	-83 db@5MHz
Controls:	IR remote, Select buttons on the front panel & RS232
PC RS232 Control :	RS232 interface serial via DRV on a PC
Gain control:	60MHz 0.1 db gain flatness
Chassis Material:	Metial (T=1mm)
Safety Approvals:	CE, FCC, RoHS(2002/95/EC).
Dimensions (LWH):	19 " x 7.87 " x 3.46 " (482mm x 200mm x 88mm)
Power Supply:	DC12V / 2A (consumption 1.6A Max) Use Universal Switch Type 50/60Hz, 100~230 VAC
Shipping Weight :	3.25 Kgs / 5.42 lb

As product improvements are continuous, specifications are subject to change and without notice.

RS-232 SERIAL INTERFACE

RS-232 SERIAL INTERFACE CONNECT a PC or CONTROL SYSTEM

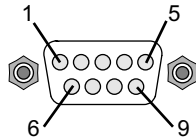

RS-232 SERIAL INTERFACE

Pin	RS-232	Definition
1	-----	Not used
2	TX	Transmitter
3	RX	Receiver
4	-----	Not used
5	GND	Ground
6	-----	Not used
7	-----	Not used
8	-----	Not used
9	-----	Not used

RS232

The Shinybow switcher can be controlled via the RS-232 serial control port to allow for interfacing to a PC, or similar third party control system.

The serial communication parameters are 9600 baud, 8 bit, No Parity and 1 stop bit - this is often referred to as 9600 8N1. When the unit recognises a complete command it will perform the requested action - there is no delimiter character required.

The unit does not send out a message when a value is changed from the front panel or by IR control. If the unit needs to be controlled via the front panel in addition to the RS232 control, you should regularly poll the unit status to ensure the control system accurately reflects the current settings.

PROTOCOL COMMANDS

To Switch Inputs to Outputs

`SBI0X0Y` - Where X is Output Number (1-8) and Y is Number (1-8)

Unit will respond with

`SBUD0XOY` - Where X is Output Number (1-8) and Y is Input Number (1-8)

Example : Send Input 8 to Output 7

`SBI08O07` -Send

`SBUD08O7` -Rcvd

RS-232 SERIAL COMMANDS

MORE STUFF FOR SB-5588



Note: Turning the unit System Power Off over RS232 will distinguish the LED display leaving only the Power Switch LED on. The Video and Audio outputs will also mute. While the unit is turned off by RS232 it will continue to accept and act upon switching commands. For example, if the unit is in the off mode (via RS232) and you send a command to switch an input to an output, that route will complete and the video and audio will now appear on that channel only. The front panel LED for that particular output will also show the input selected (for that single output channel only). The remaining LED's will remain off and video and audio outputs muted. The unit will still return status and change messages in response to commands sent while in Power Off state. A hard reset command (SBALLRST) will return the unit to normal operation and also unlock the front panel.

Power Off mode.

SBSYSMOF - Put system into Standby (Soft Power Off)

SBSYSMON - Bring unit out of Standby (Soft Power On)

Unit will respond with

SBALOFAK - Unit is in Standby

SBALONAK - Unit is no longer in Standby

Example : Put Unit in Standby (Soft Power)

SBSYSMOF -Send

SBALOFAK -Rcvd

FRONT PANEL LOCK



Note : Hard resetting the unit will unlock the Front Panel controls.

SBSYSMLK - When front panel is locked, changes can only be made by RS232

SBSYSMUK - Front Panel Unlock

Unit will respond with

SBSYSLOK - Front Panel has been Locked

SBSYSULK - Front Panel has been Unlocked

Example : Lock Front Panel Buttons

SBSYSMLK -Send

SBSYSLOK -Rcvd

UNIT RESET

SBALLRST - Reset every output to Input 1

Unit will respond with

SBRSTACK - Unit has reset each Output to Input 1

Example : Reset all outputs to Input 1

SBALLRST -Send

SBRSTACK -Rcvd

TYPICAL APPLICATION

8x Component sources to 8x Component Output Matrix Switcher

SHINYBOW
SB-5588 V2

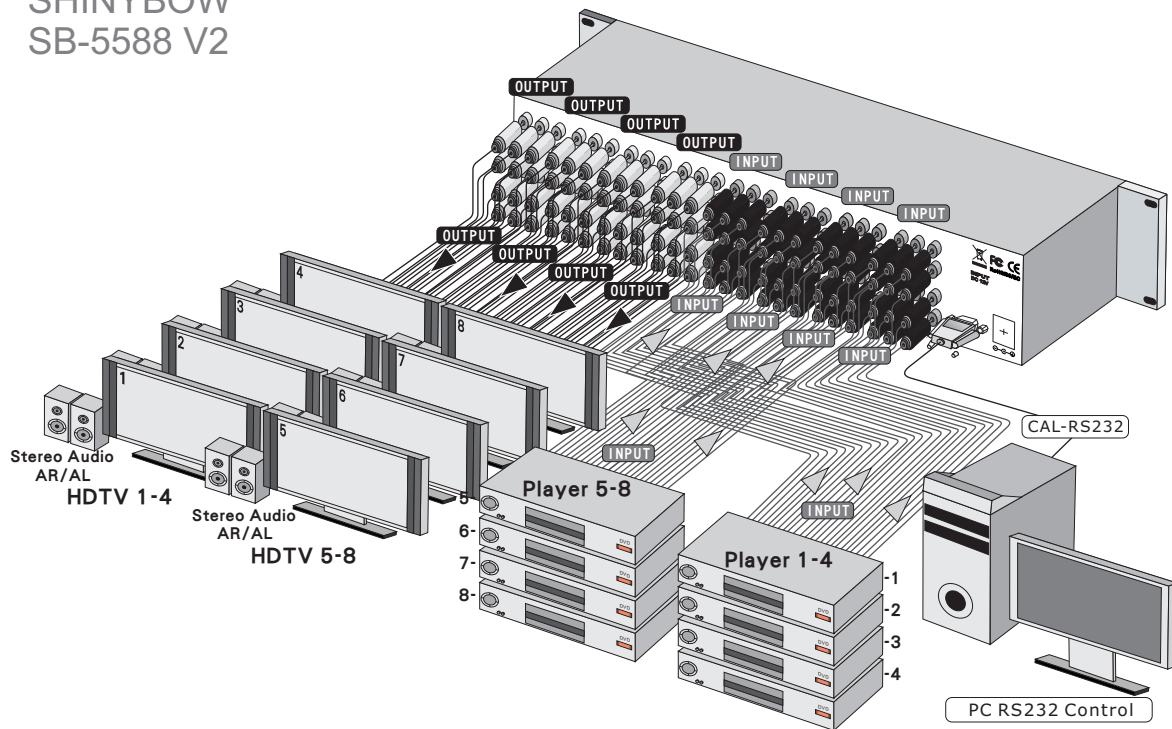

INSTALLING

CONTROL PORTS :

1. IR REMOTE - IR Remote Controller
2. RS 232 Interface - RS 232 interface system

INPUTS 1 ~ 8 PORT HD SOURCE SIGNALS :

- COMPONENT VIDEO - Component Video(YP_BPR), connector with RCA
- DIGITAL - Digital Audio(PCB), connector with RCA
- AUDIO - Stereo Audio (AR/AL), connector with RCA

OUTPUT 1 ~ 8 PORT HDTV DISPLAY SIGNALS :

- COMPONENT VIDEO - Component Video(YP_BPR), connector with RCA
- DIGITAL - Digital Audio(PCB), connector with RCA
- AUDIO - Stereo Audio (AR/AL), connector with RCA

SB-5588 SUPPORT COMPONENT EIGHT INPUTS MATRIX TO EIGHT SWITCH OUTPUTS
SUPPORT CONTROL IR & RS 232 INTERFACE SYSTEM PORTS.

LIMITED WARRANTY

SHINYBOW WARRANTY

SHINYBOW Technology warrants this product against defects in materials and workmanship for a period of **1 year** from the date of purchase.

Should this product, in SHINYBOW Technology,s opinion, Prove defective within this warranty period, SHINYBOW Technology, at its option, repair this product without charge, to whatever extent it shall deem necessary to restore said product to proper operation condition.

This warranty does not apply if the fault has been caused by misuse, improper handling care, electrical or mechanical abuse, and abnormal operating condition or non-SHINYBOW Technology authorized modification to the product.

If repairs are necessary under the warranty policy, the original purchaser must return the product to local distributor, freight prepaid.

After repairs are complete, the product will be returned.

REGULATORY COMPLIANCE

The product complies with the relevant standards for CE, FCC and RoHS approval.

The power Adaptor/Supply has been tested for compliance with UL.CSA and CE standards.

TROUBLESHOOTING

If you experience a <no signal> with this switcher or distributor outputs, first make certain that the signal being fed to its inputs is acceptable.

Disconnect the cables from the this switcher or distributor inputs and connect them directly to an appropriate monitoring device, if you do not see or hear a signal the problem may well be he signal source itself. Also check that the AC outlet you have used to power the switcher or distributor is actually providing power as a wall switch often controls an AC outlet.

The second most common problem with this switcher or distributor revolves around the cables, Inspect the cables for loose connectors or cable damage such as crushed cable or cables with cuts or nicks. Replace any cable exhibiting these problem.

You also must use the highest quality cables if you want to achieve the best results. Poor quality cables provide will poor quality signals.

SHINYBOW™

MULTIMEDIA AUDIO AND VISUAL
